

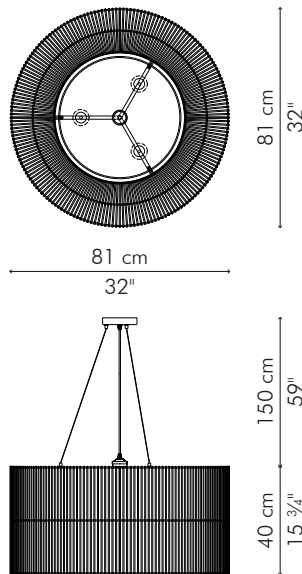

## HANGING LAMP, large



INDOOR

 4 kg / 11 lbs

 7.20 kg / 18 lbs

 0.318 m<sup>3</sup>

3 x 75 watts

Surface mounted pre-wired lamp

E26 / E27

110V 60Hz / 230V 50Hz

**INDOOR** Buri (palm leaf spines), powder coated steel, handmade paper, Mylar

Brown

LKIO-B-3115

## HANGING LAMP, medium

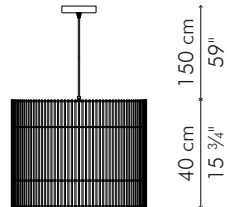
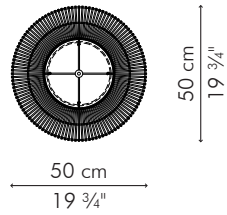

### INDOOR

 1.05 kg / 11 lbs

 2.35 kg / 18 lbs

 0.126 m<sup>3</sup>

1 x 100 watts

Surface mounted pre-wired lamp

E26 / E27

110V 60Hz / 230V 50Hz

**INDOOR** Buri (palm leaf spines), powder coated steel, handmade paper, Mylar

Brown

LKIO-B-1915

## HANGING LAMP, small

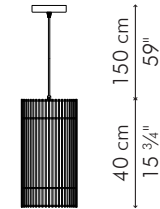
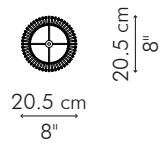

### INDOOR

 0.85 kg / 11 lbs

 1.50 kg / 18 lbs

 0.024 m<sup>3</sup>

1 x 75 watts

Surface mounted pre-wired lamp

E26 / E27

110V 60Hz / 230V 50Hz

**INDOOR** Buri (palm leaf spines), powder coated steel, handmade paper, Mylar

Brown

LKIO-B-0815